

ASSEMBLY LINE SCRAPBOOKING

September 2004 *Club Scrap*® Textiles & Notions

Materials:

- CS® Textiles and Notions Kit
- Black Thread

Tools:

- Adhesive
- Vellum Adhesive
- Glue Stick
- Tape
- 12" Paper Trimmer
- Scissors
- Needle
- Black Pen/Marker
- Paper Piercing Tool
- Cork Board
- ColorBox Stylus Tool with Blender Tip

Fraction to Decimal Conversions

$1/8" = .125"$ $1/2" = .5"$ $7/8" = .875"$

$1/4" = .25"$ $5/8" = .625"$

$3/8" = .375"$ $3/4" = .75"$



Layout #1 and #2

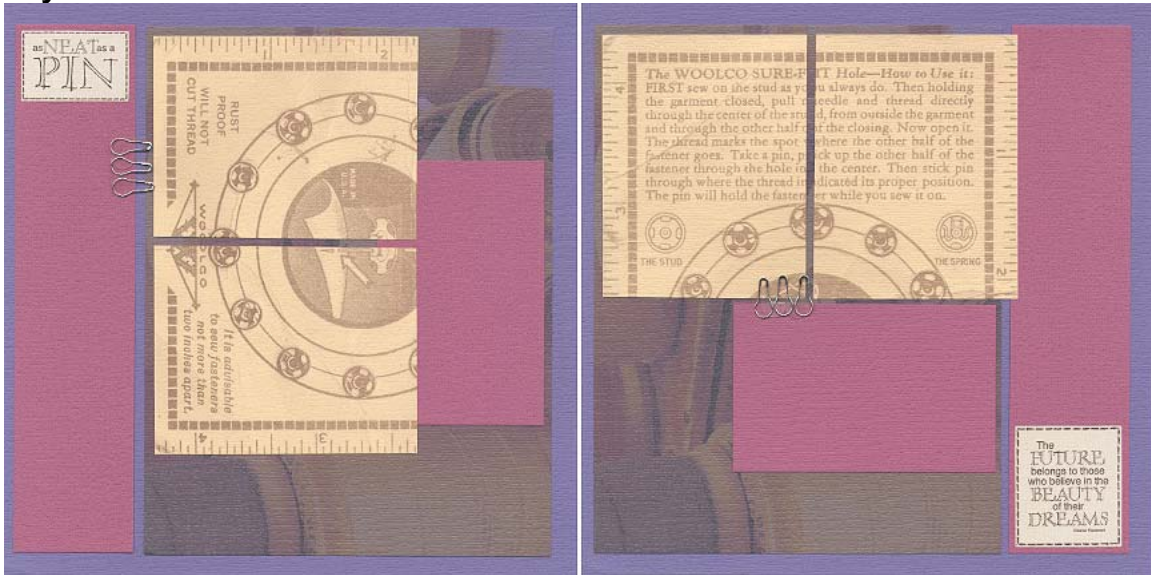

- (2) 12x12 Violet Plain
- (2) 8.5x11 Violet Print
- 8.5x11 Mauve Plain
- 8.5x11 Butter Print
- Adhesive Canvas Quotes
- Memory Safety Pins

1. Trim the 8.5x11 Mauve Plain at 6 and 3.5". Turn the 3.5x11 strip horizontally and cut at 5.5".

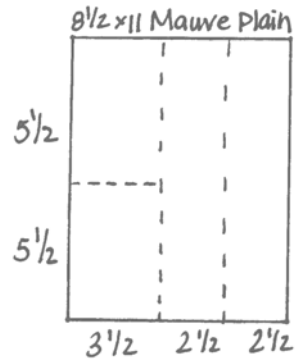

2. Cut the 8.5x11 Butter Print vertically in half at 4.25". Stack and rotate horizontally; trim at 5.5".

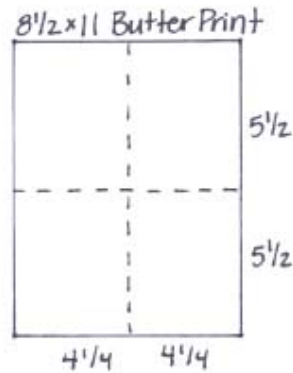

Layout #3 and #4

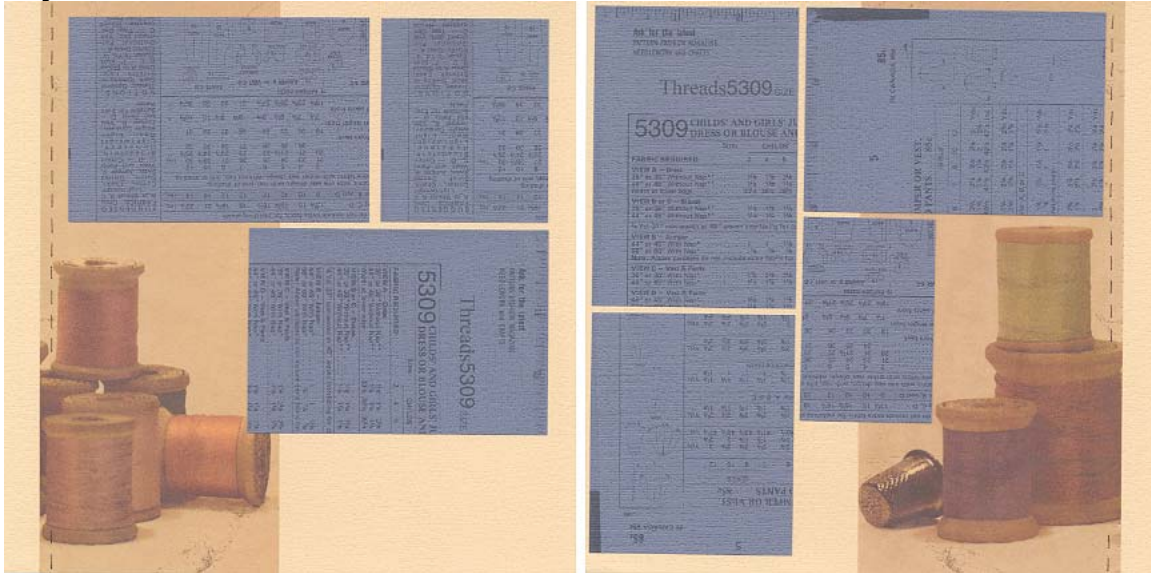

- (2) 12x12 Translucent Spool Print
- (2) 12x12 Butter Plain
- (2) 8.5x11 Blue Print
- Black Thread
- Needle
- Paper Piercing Tool
- Cork Board
- Tape

1. Trim the 12x12 Translucent Spool Left Companion Print, with the spool image on the left side of the trimmer, at 5".

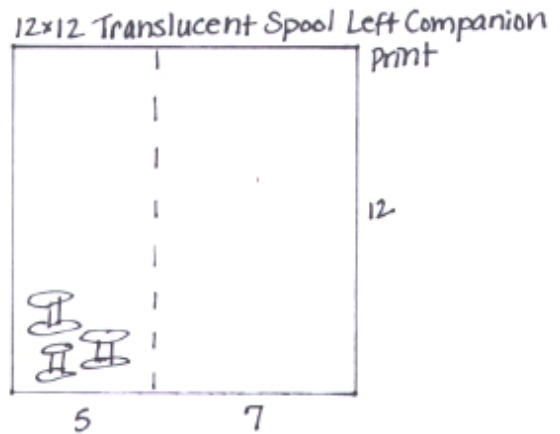

- Cut the 12x12 Translucent Spool Right Companion Print, with the spool image on the right side of the trimmer, at 5.5".

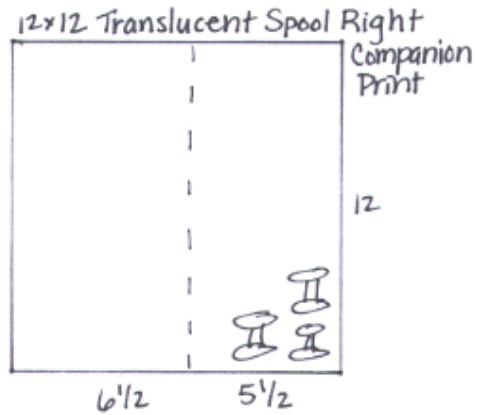

- Trim one 8.5x11 Blue Print horizontally at 10.5 and 6.25". Rotate the 6.25x8.5 horizontally and trim at 4.25". Trim the 4.25x8.5 horizontally at 5".

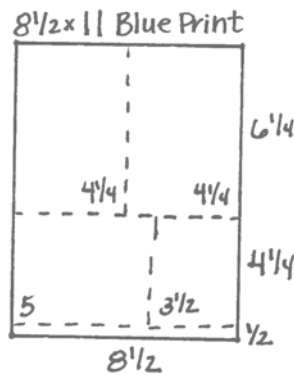

- Trim the remaining 8.5x11 Blue Print horizontally at 10.5 and 6.25". Trim the 6.25x8.5 piece horizontally at 4.25". Cut the 4.25x8.5 piece horizontally at 7.75 and 5".

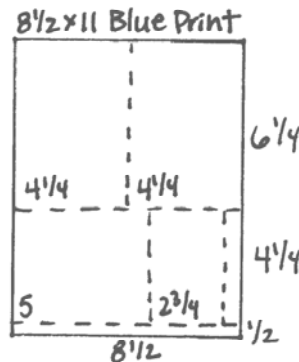

- Stitch along the outer edge of the Translucent Print trips with a needle and black thread. Tape thread ends onto the back of the page.



Layout #5 and #6

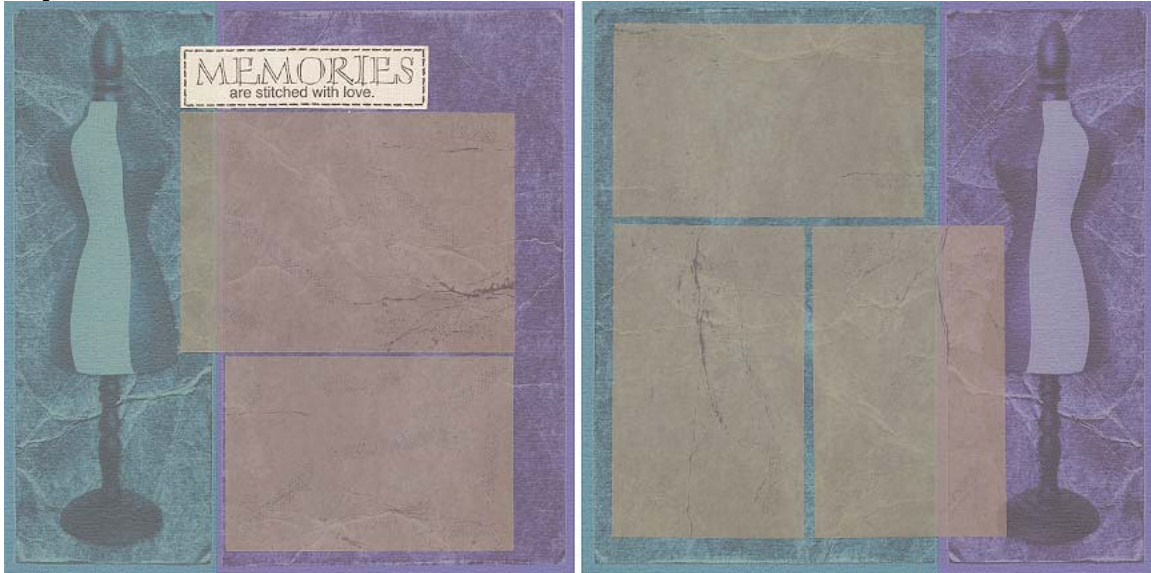

- (2) 12x12 Teal Print
- 12x12 Violet Right Mirror Print
- 7x12 Translucent Spool Left Companion Print (From Layout #3 and #4)
- 6.5x12 Translucent Spool Right Companion Print (From Layout #3 and #4)
- Adhesive Canvas Quotes

1. Trim the 12x12 Violet Right Mirror Print, with the bodice image on the right side of the trimmer, at 7.5".

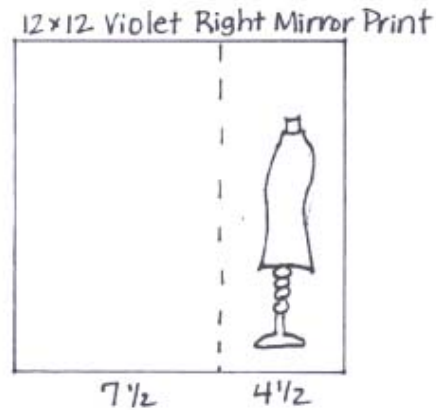

- Cut the 7x12 Translucent Print horizontally at 11 and 6". Rotate the 6x7 horizontally; trim at 4".

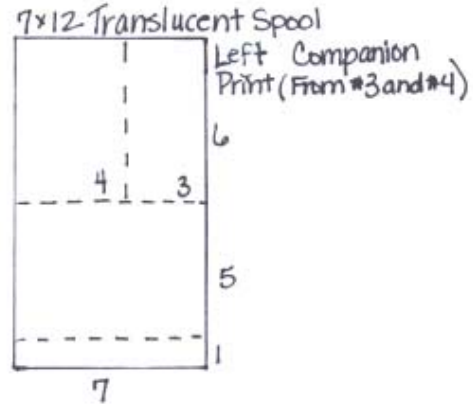

- Trim the 6.5x12 Translucent Print horizontally at 8 and 4".

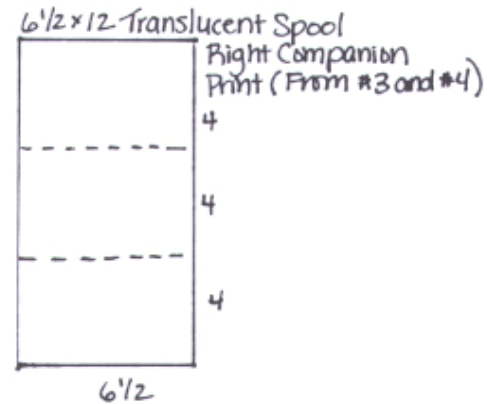

- Cut "Memories are stitched with love" from the Adhesive Canvas Quotes.



Layout #7 and #8

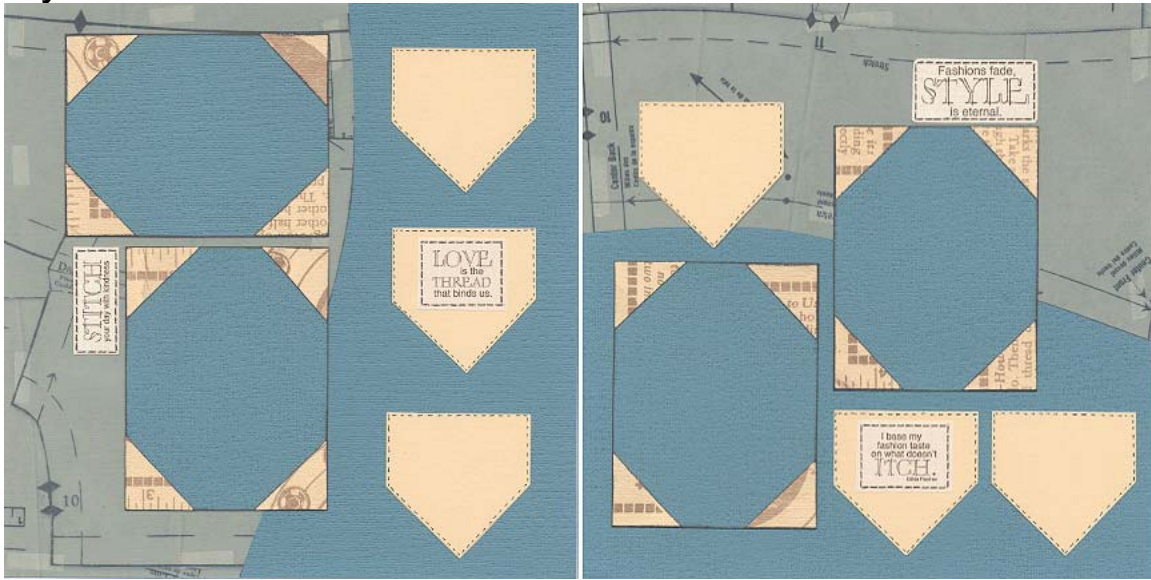

- (2) 12x12 Teal Plain
- 12x12 Translucent Pattern Print
- 8.5x11 Butter Print
- 8.5x11 Teal Plain
- Adhesive Canvas Quotes
- Black Pen/Marker
- Black Ink

1. Trim the 12x12 Translucent Pattern Print along printed curved line.

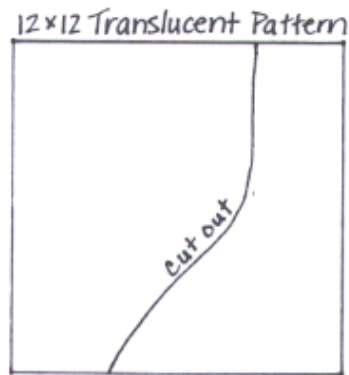

- Cut the 8.5x11 Teal Plain vertically in half at 4.25". Stack and rotate horizontally; cut in half at 5.5". This makes four 4.25x5.5 photo mattes.

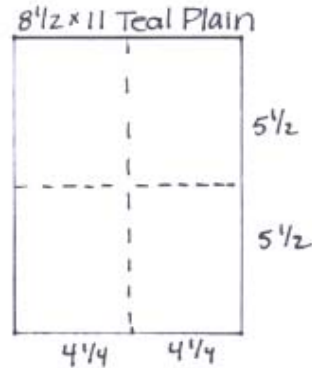

- Trim the 8.5x11 Butter Print vertically at 6 and 3". Trim one 3x11 piece at 9, 6 and 3". Trim the second 3x11 piece at 10, 9, 6 and 3".

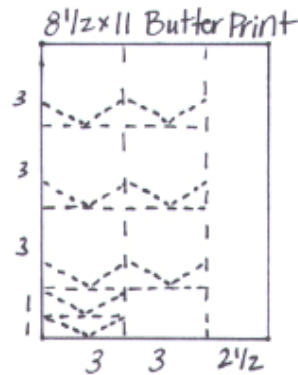

- Cut the bottom corners of six 3" Butter Print squares to create "pockets." Turn each one over to the plain side; add stitch marks around the outside perimeter of the pockets with a black marker. Use the corners to accent the Teal photo mattes. Four more corners can be made from the 1x3 pieces of Butter Print.
- Attach the pockets with adhesive around the bottom and sides, but leave the top and middle open so that you can insert notes and pictures in the pockets.
- Cut "Stitch your date with kindness" and "Fashions fade, style is eternal" from the Adhesive Canvas Quotes.



Layout #9 and #10

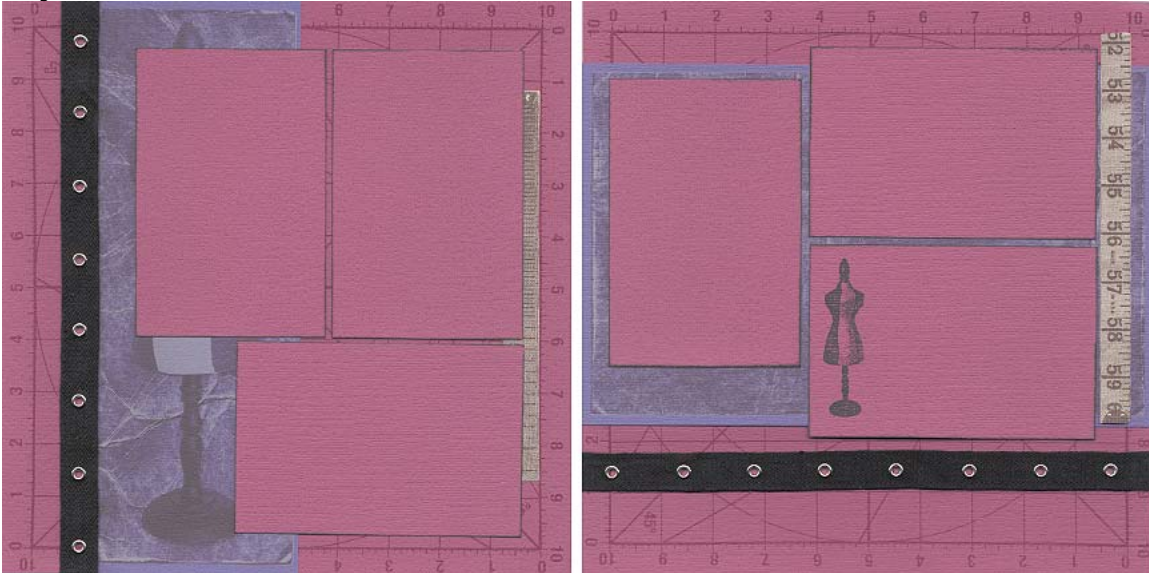

- (2) 12x12 Mauve Print
- 12x12 Mauve Plain
- 12x12 Violet Left Mirror Print
- Adhesive Canvas Quotes
- Black Eyelet Twill
- Black Ink
- Wood Mounted "Bodice" Stamp

1. Trim the 12x12 Mauve Plain in half at 6". Stack and rotate horizontally; cut at 8 and 4".

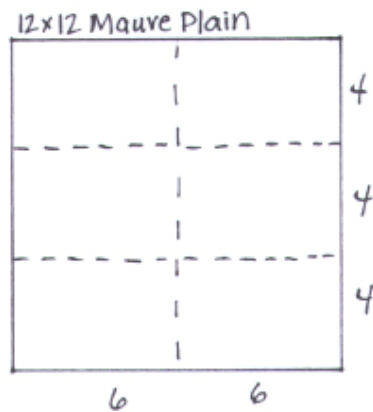

- Cut the 12x12 Violet Left Mirror Print, with the image on the left side of the trimmer, at 4.5".

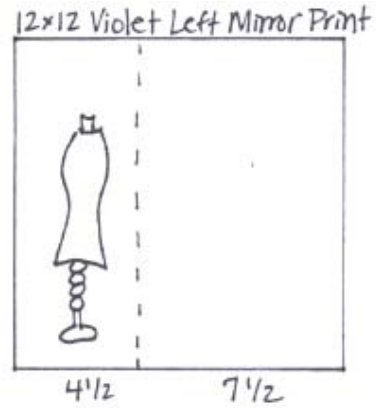

- Stamp the Bodice image onto the left side of one of the horizontal 4x6 Mauve photo mattes with black ink.
- Cut the measuring tape images from the Adhesive Canvas Quotes.



Layout #11 and #12

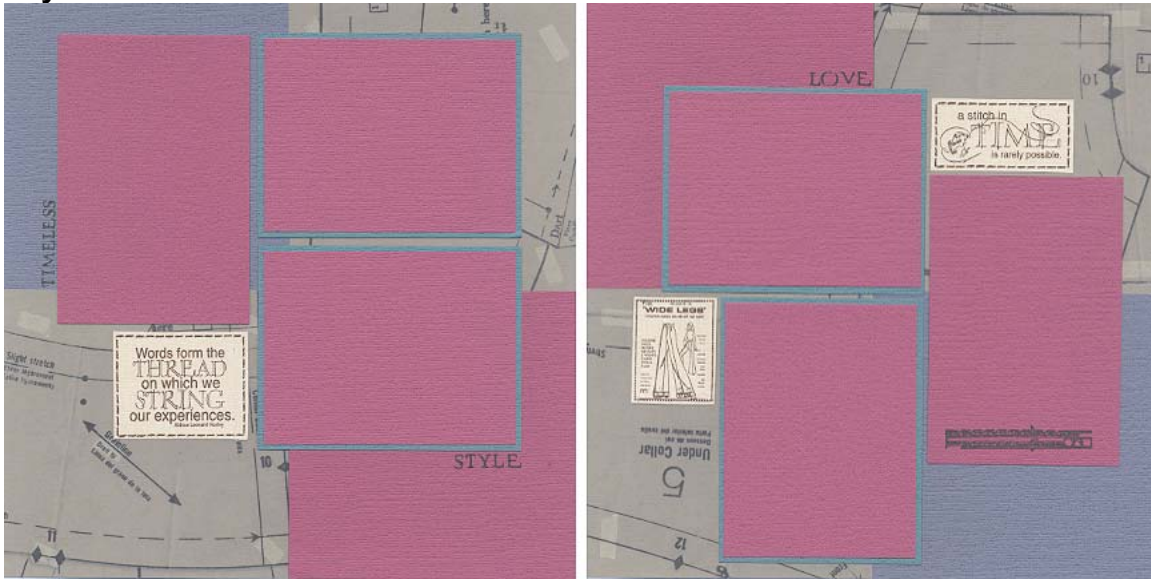

- (2) 12x12 Blue Plain
- 12x12 Translucent Pattern Print
- 12x12 Mauve Plain
- 8.5x11 Teal Plain
- 8.5x11 Mauve Plain
- Adhesive Canvas Quotes
- Frou-Frou Folio Stencil
- Black Ink
- Wood Mounted "Rule" Stamp
- Stylus Tool

1. Trim the 12x12 Translucent Pattern Print in half. Stack and rotate horizontally; cut in half again at 6" make four squares.

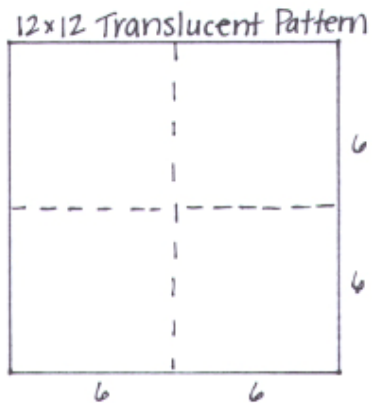

- Cut the 12x12 Mauve Plain in half at 6". Stack and rotate horizontally; trim at 10 and 6".

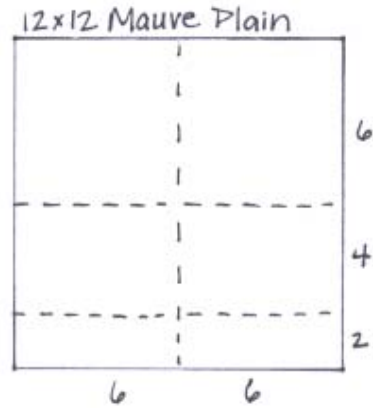

- Trim the 8.5x11 Teal Plain vertically at 4.25". Stack and rotate horizontally; cut in half at 5.5".

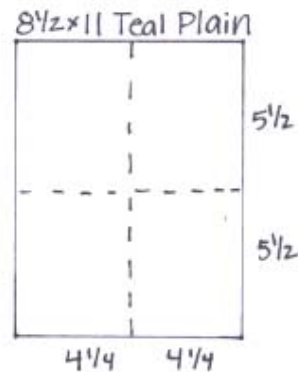

- Place the 8.5x11 Mauve Plain into the trimmer vertically and cut at 8 and 4". Stack the 4x11 horizontally and trim at 10.5 and 5.25".

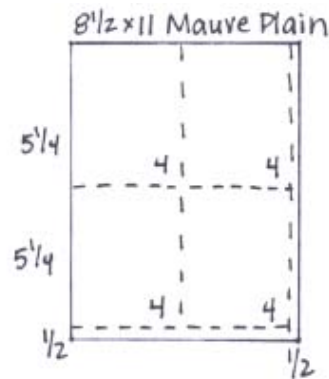

- Cut "Words from the Thread..." and "a stitch in Time.." along with the "Wide Legs" from the Adhesive Canvas Quotes.
- Stencil the words "Timeless, Style, and Love" onto the layout with black ink and a stylus tool.

