

Assembly Line Scrapbooking

October 2003 Club Scrap® Hearth and Home

Materials:

- Club Scrap® Hearth and Home Kit

Tools:

- 12" Paper Trimmer
- Adhesive
- Black Ink
- Paper Piercing Tool
- Cork Board
- Gold Brads

Fraction to Decimal Conversions
 $1/8" = .125"$ $1/2" = .5"$ $7/8" = .875"$
 $1/4" = .25"$ $5/8" = .625"$
 $3/8" = .375"$ $3/4" = .75"$



Layout #1 and #2

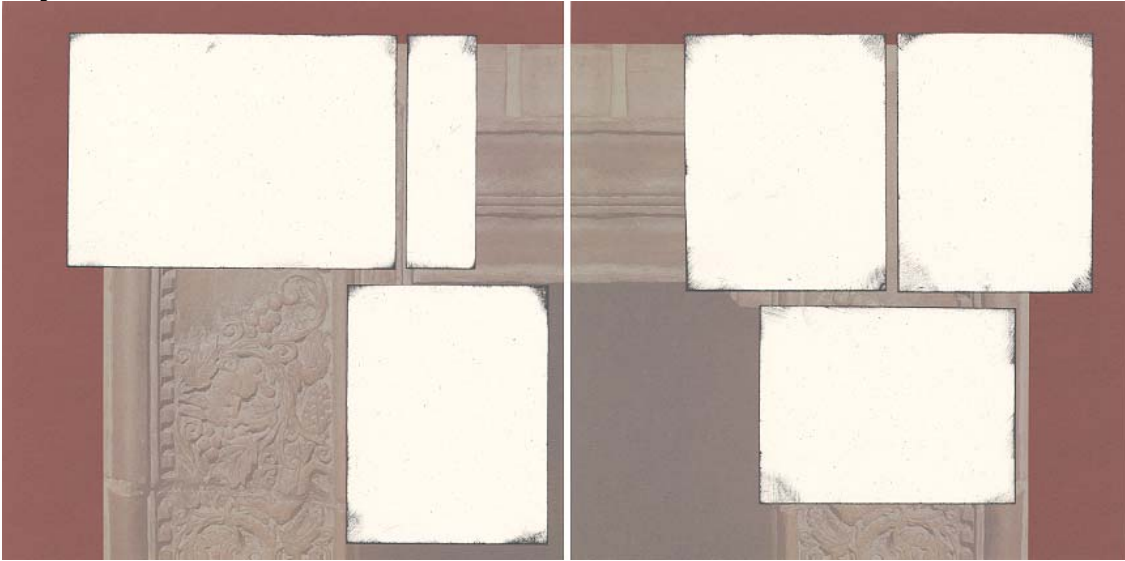

- (2) 12x12 Brick Plain
- 12x12 Left Stone Hearth Print
- 12x12 Right Stone Hearth Print
- (2) 8.5x11 White Speck Plain
- Black Ink

1. Trim the 12x12 Left Stone Hearth Print, with the top of the print on the right, at 9.75". Rotate and cut (upside down) at 11". See diagram for position of cuts.

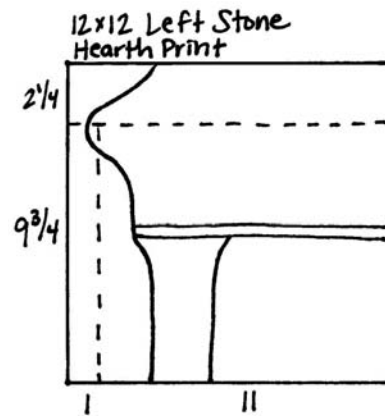

- Trim the 12x12 Right Stone Hearth Print, with the top of the print on the right side of the page, at 9.75". Rotate horizontally so that the print is upright, and cut at 11".

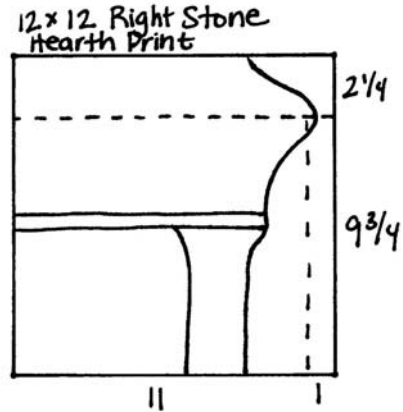

- Trim one 8.5x11 White Speck Plain vertically at 4.25". Stack and rotate horizontally; cut at 5.5".

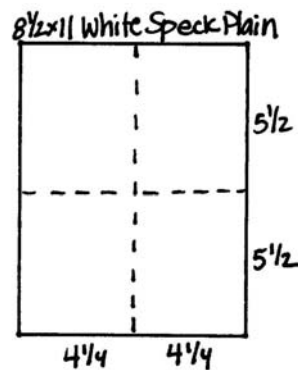

- Place the second 8.5x11 White Speck Plain into the trimmer horizontally and cut at 6". Trim the 5x8.5 horizontally at 7".

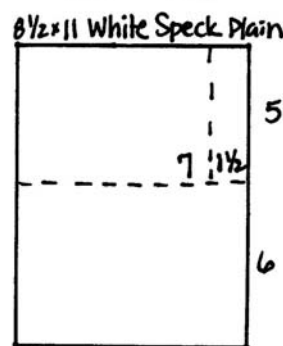

- Place the 9.75x11 Right Stone Hearth Print sideways on the RIGHT page and the 9.75x11 Left Stone Hearth Print sideways on the LEFT page, making sure the dark portions of the paper meet in the center.



Layout #3 and #4

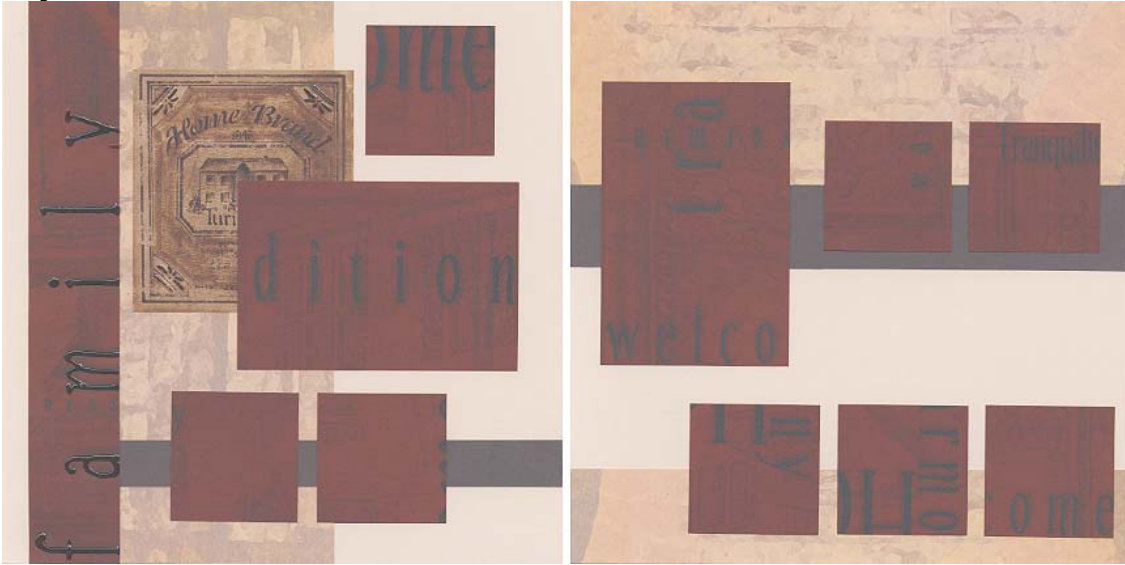

- (2) 12x12 Light Brick Plain
- 12x12 Brick Print
- 12x12 Collage Print
- 8.5x11 Broom Print
- Ranger Glossy Accents
- Stickers

1. Trim the 12x12 Brick Print at 10 and 6".

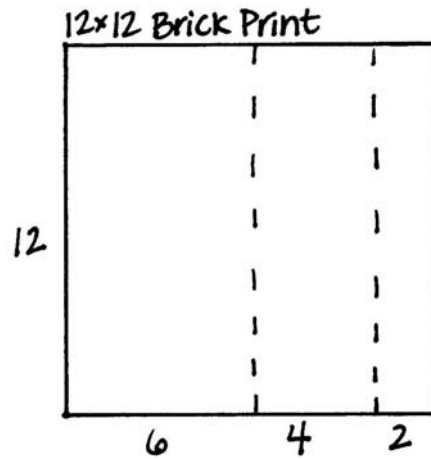

- Cut the 12x12 Collage Print, with the top of the print on the right, at 10, 7.25, 4.5, and 4". Rotate the 4x12 horizontally and cut in half. Stack the two 2.75x12 strips horizontally and trim at 11, 8.25, 5.5, and 2.75".

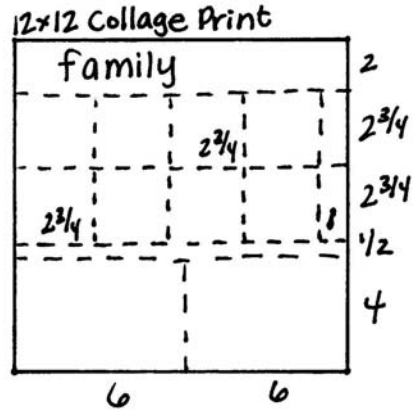

- Trim the 8.5x11 Broom Print vertically at 7.5 and 5". Use the plain side of the 2.5x11 and 1x11 for this layout.

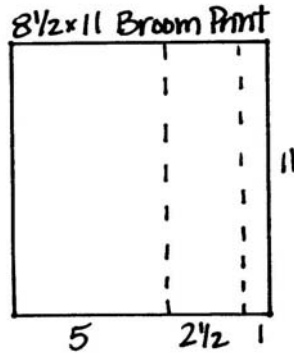

Layout #5 and #6



- (2) 12x12 Charcoal Plain
- 8.5x11 Left Windows Print
- 8.5x11 Right Windows Print
- 8.5x11 Brick Plain
- 1 Brass Frame
- (2) Gold Brads
- Chip Chart Die Cuts
- Paper Piercing Tool
- Cork Board

1. Trim the 8.5x11 Brick Plain vertically at 4.25". Stack and rotate horizontally; cut at 5.5".

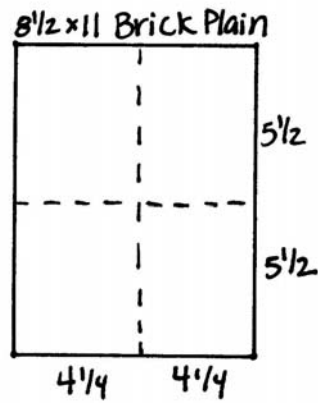

- Cut the 8.5x11 Right Windows Print vertically at 4.25". Stack and rotate horizontally; cut at 5.5".

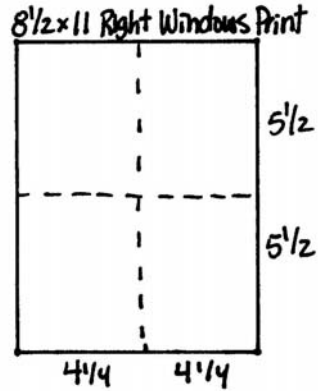

- Trim the 8.5x11 Left Windows Print horizontally at 5.5".

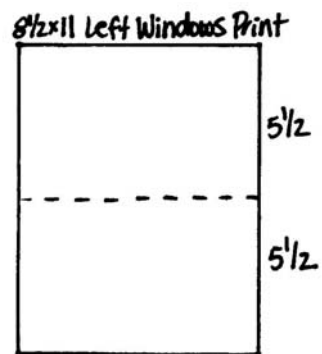

Layout #7 and #8

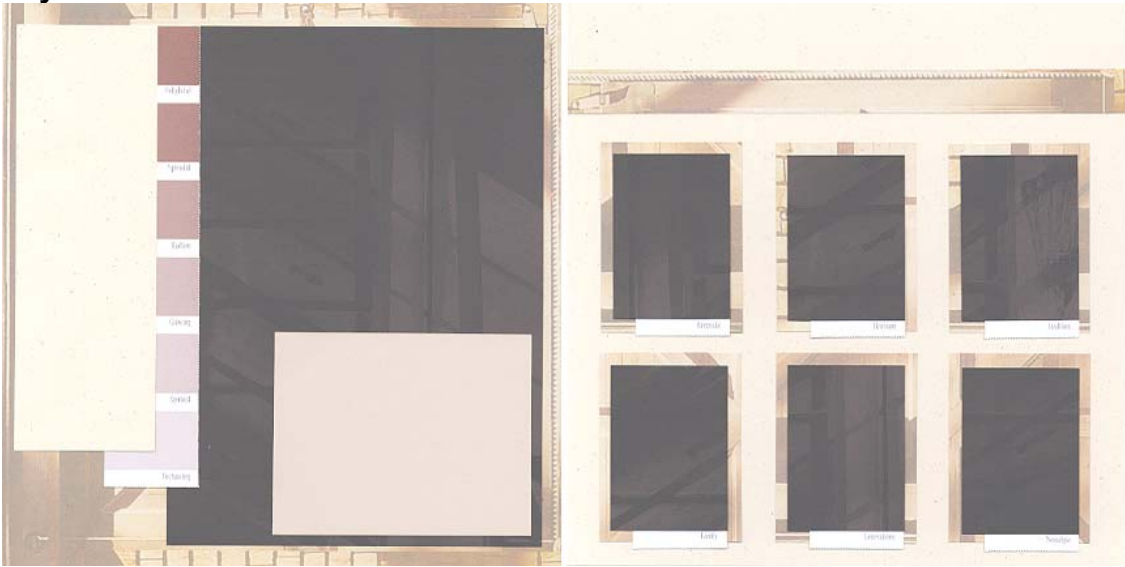

- (2) 12x12 Door Print
- 12x12 Speckled White Plain
- 8.5x11 Broom Print
- 5x11 Broom Print (From Layout #3 and #4)
- 4.25x5.5 Windows Photo Matte (From Layout #5 and #6)
- Chip Chart Sheets

1. Trim one 12x12 Door Print at 11". Rotate horizontally and cut at 9". Place the 9x11 horizontally into the trimmer and cut at 8 and 4". Stack the two 4x9 strips horizontally and cut at 6 and 3".

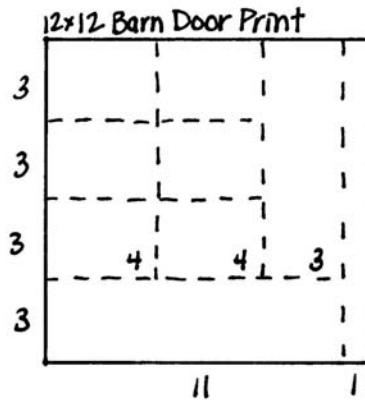

2. Place the 5x11 Broom Print vertically into the trimmer and cut in half at 2.5". Stack and rotate horizontally and trim at 10.5, 7, and 3.5".

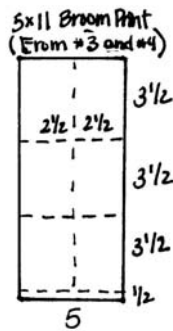

Layout #9 and #10

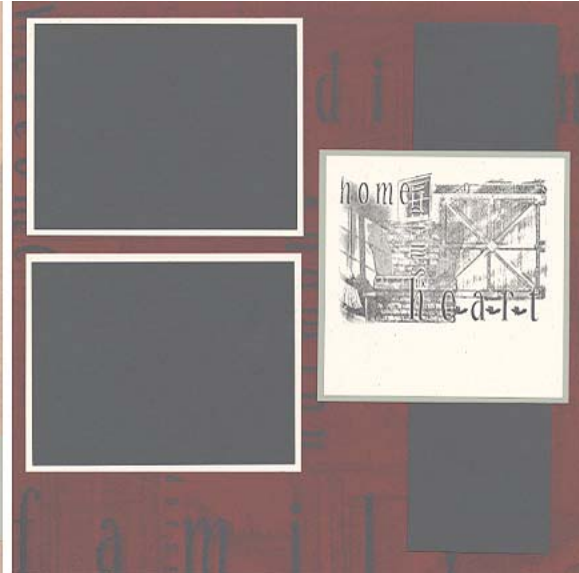
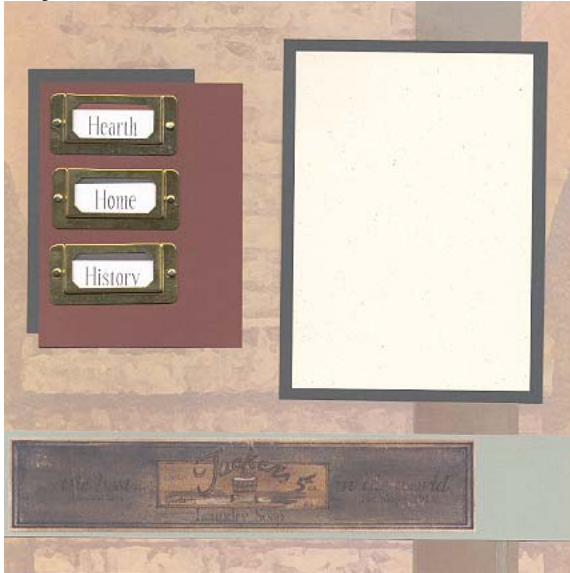

- 12x12 Brick Print
- 12x12 Collage Print
- 12x12 Speckled White Plain
- (2) 8.5x11 Black Plain
- 8.5x11 Light Grey Plain
- Chip Chart Sheet

- (6) Gold Brads
- (3) Brass Frames
- Paper Piecing Tool
- Cork Board
- Noir Black Palette Ink
- Large Wood Mounted Stamp

1. Trim the 12x12 White Speckled Plain at 9.5 and 5". Rotate the 5x12 horizontally and cut at 7". Place the 4.5x12 horizontally into the trimmer and cut at 11.5 and 5.75".

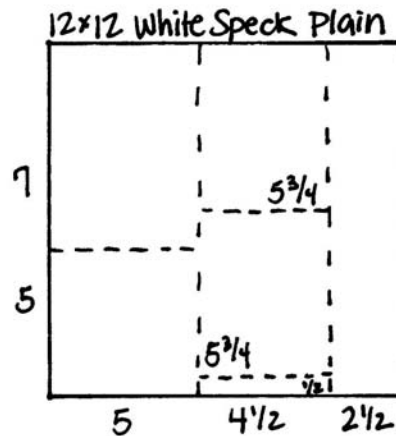

- Cut one 8.5x11 Black Plain vertically at 5.5". Rotate the 5.5x11 horizontally and cut at 7.5".

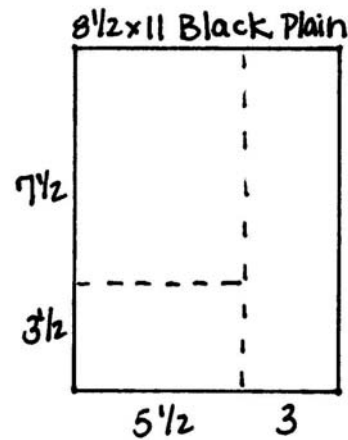

- Trim the remaining 8.5x11 Black Plain vertically at 4.25". Rotate one 5.5x8.5 horizontally and cut in half at 5.5".

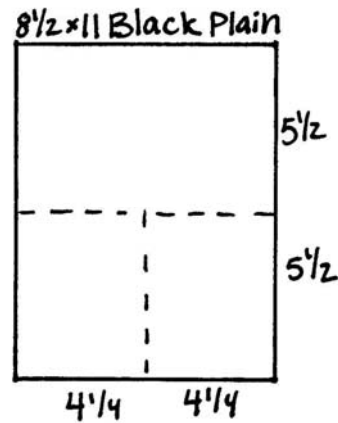

- Place the 8.5x11 Light Grey Plain into the trimmer vertically and cut at 5.25". Rotate the 5.25x11 horizontally and trim at 5.75".

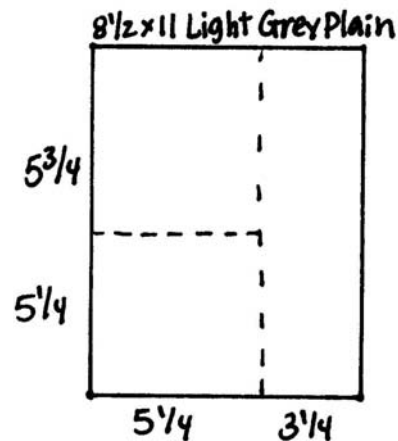

- Stamp the large wood mounted stamp with black ink onto the 5x5 White Speck Plain.

