

Assembly Line Scrapbooking

2007 Rolling Retreat Denver Special Edition

Supplies:

- 2 (12x12) Wheel and Sprocket Green Mini-Fork Print
- 12x12 Wheel and Sprocket Purple Ten Speed Print
- 12x12 Wheel and Sprocket Black Tires and Teeth Print
- (2) 8.5x11 Wheel and Sprocket Purple Plain
- (2) 12x12 Workbench Steel Print
- (2) 12x12 Workbench Steel Embossed
- 8.5x11 Workbench Steel Embossed
- (2) 8.5x11 Retro Dark Raspberry Plain
- (2) 8.5x11 Time and Space Silver Plain
- (2) 8.5x11 Time and Space Mauve Dust Plain
- (2) 12x12 Stratosphere Green Print
- 12x12 Stratosphere Fuchsia Print
- (2) 12x12 Science Sapphire Plain
- (2) 12x12 Science Ebony Foil Print
- (2) 12x12 Science Amethyst Print
- (2) 8.5x11 Science Ebony Print
- 8.5x11 Science Ebony Crepe Print
- Framed Circular Slide Frames
- Framed 12x12 Blue Print
- Culinary Cuts

Tools:

- Adhesive
- Black Ink
- 12" Paper Trimmer



Layout #1 and #2: 8's in the Gutter; 12x12 Mathematic Matting

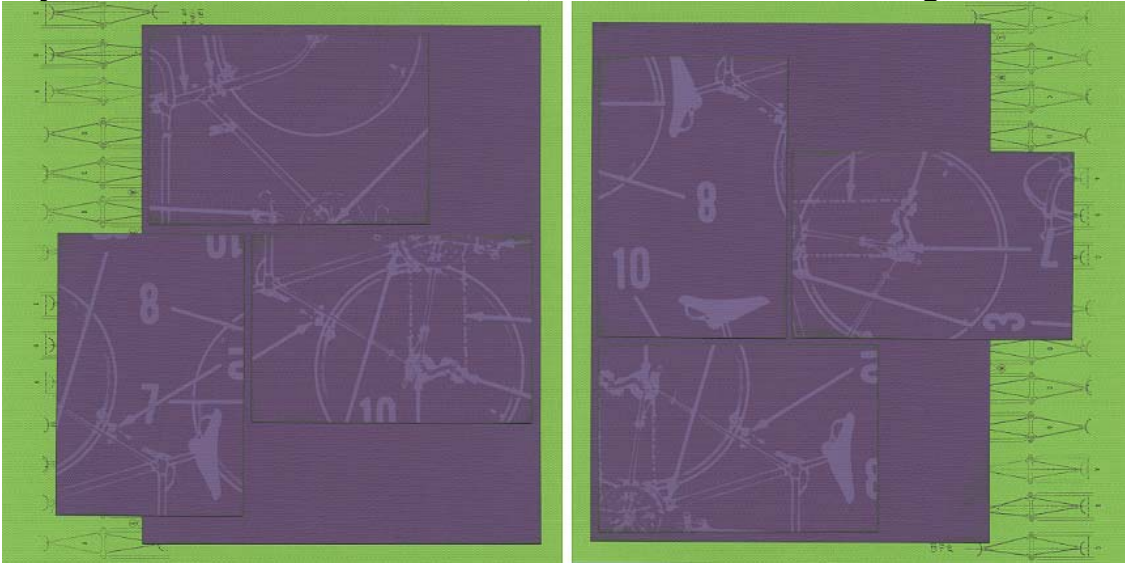

- (2) 12x12 Wheel and Sprocket Green Mini-Fork Print
- 12x12 Wheel and Sprocket Purple Ten Speed Print
- (2) 8.5x11 Wheel and Sprocket Purple Plain
- Black Ink

1. Trim the 12x12 Purple Print in half at 6". Stack and rotate horizontally; cut at 8 and 4".

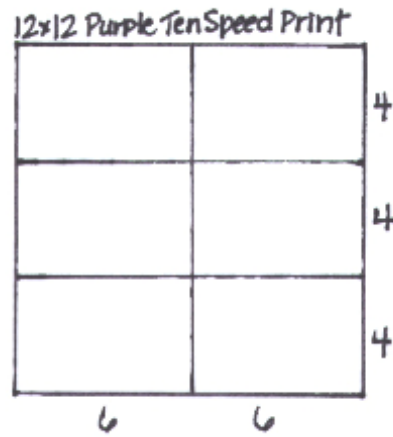

Layout #3 and #4: 12x12 Split Matte; Nesting Mattes

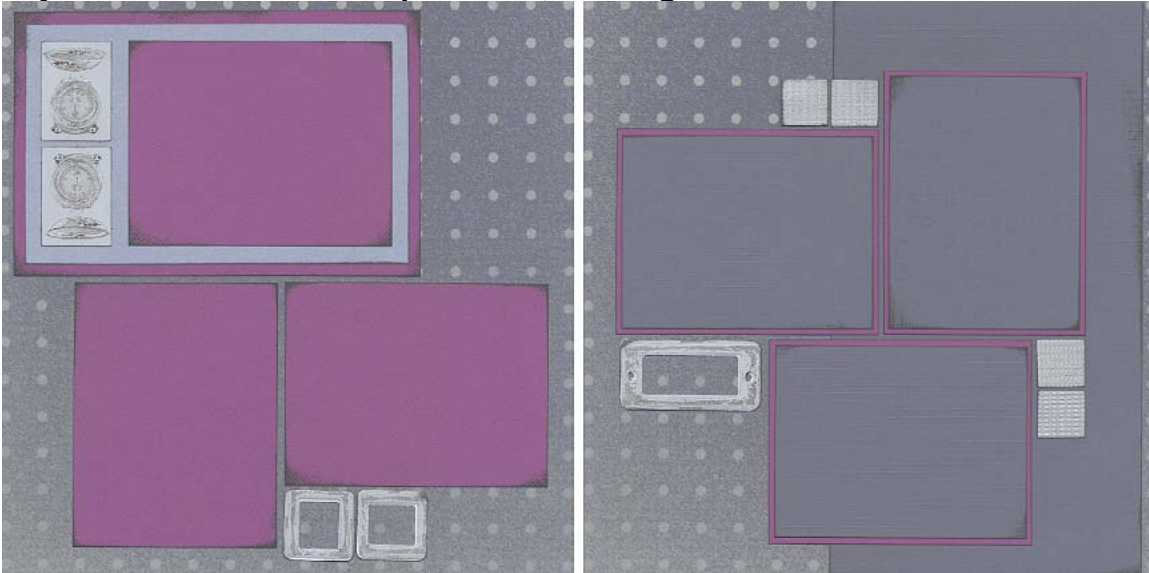

- (2) 12x12 Workbench Steel Print
- 12x12 Workbench Steel Embossed
- (2) 8.5x11 Retro Dark Raspberry Plain
- 8.5x11 Time and Space Silver Plain
- Culinary Cuts

1. Trim the 12x12 Steel Embossed at 11.75 and 6.5". Rotate the 5.25x12 horizontally and cut at 8 and 4".

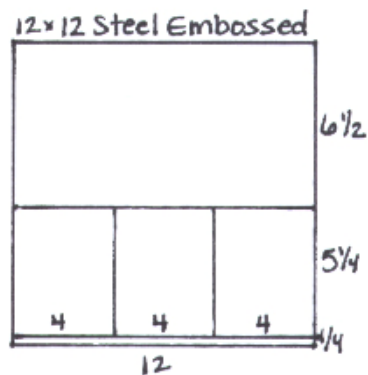

2. Cut the 8.5x11 Silver Plain horizontally at 6". Rotate the 5x8.5 horizontally and trim at 8".

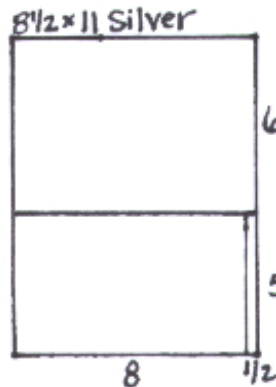

- Trim one 8.5x11 Dark Raspberry Plain vertically in half at 4.25". Stack and rotate horizontally; cut at 5.5".

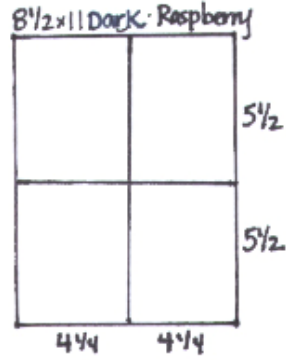

- Cut the other 8.5x11 Dark Raspberry Plain horizontally at 5.5". Rotate one 5.5x8.5 horizontally and trim at 4.25".

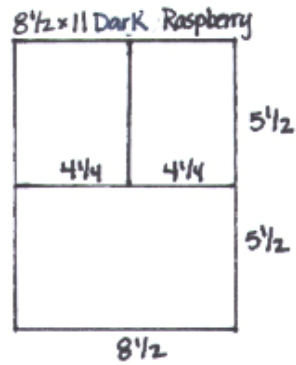

Layout #5 and #6: 12x12 Mathematic Matting; Nested Mattes

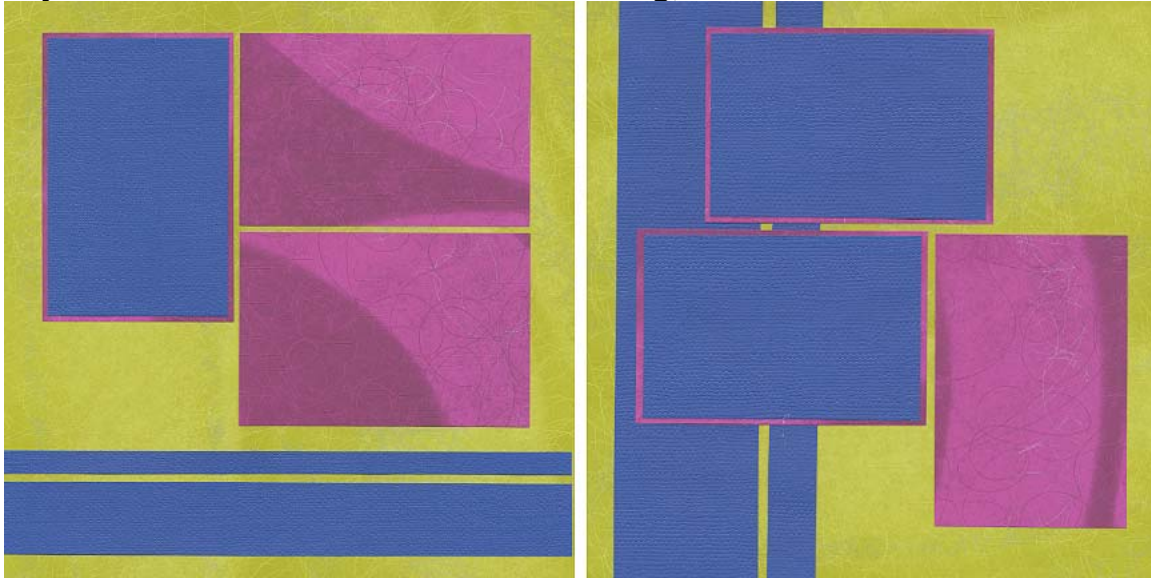

- (2) 12x12 Stratosphere Green Print
- 12x12 Stratosphere Fuchsia Print
- 12x12 Framed Blue Plain

1. Trim the 12x12 Fuchsia Print at 6". Stack and rotate horizontally; cut at 8 and 4".

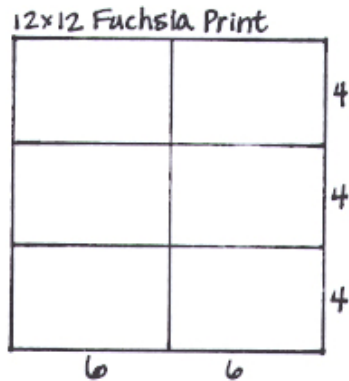

2. Cut the 12x12 Blue Plain at 11.5, 10.5, 9, 6, and 5.75". Rotate the 5.75x12 horizontally; trim at 11.25, 7.5, and 3.75".

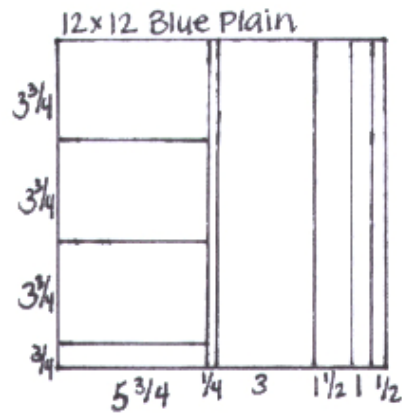

Layout #7 and #8: 12x12 Color Blocked; Paper Ribbons

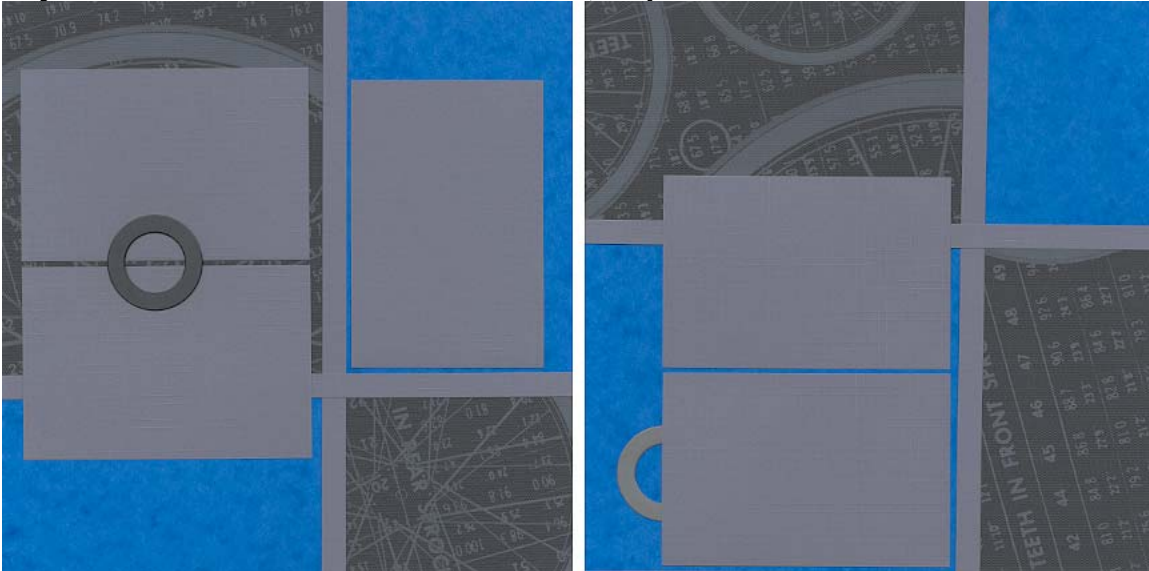

- (2) 12x12 Science Sapphire Plain
- 12x12 Wheel and Sprocket Black Tires and Teeth Print
- 12x12 Workbench Steel Embossed
- Circular Slide Frames

1. Trim the 12x12 Steel Embossed at 11.5, 11, 10.5, 10, and 6". Rotate the 6x12 horizontally; cut at 8 and 4". Trim the 4x12 horizontally in half at 6".

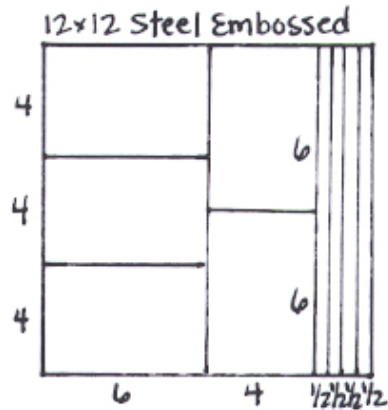

2. Cut the 12x12 Black Tires and Teeth Print at 8". Stack and rotate horizontally; trim at 7".

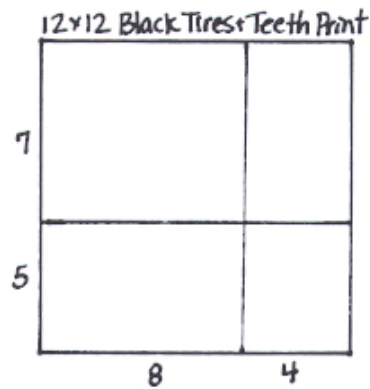

Layout #9 and #10: 8.5x11 Color-Blocked

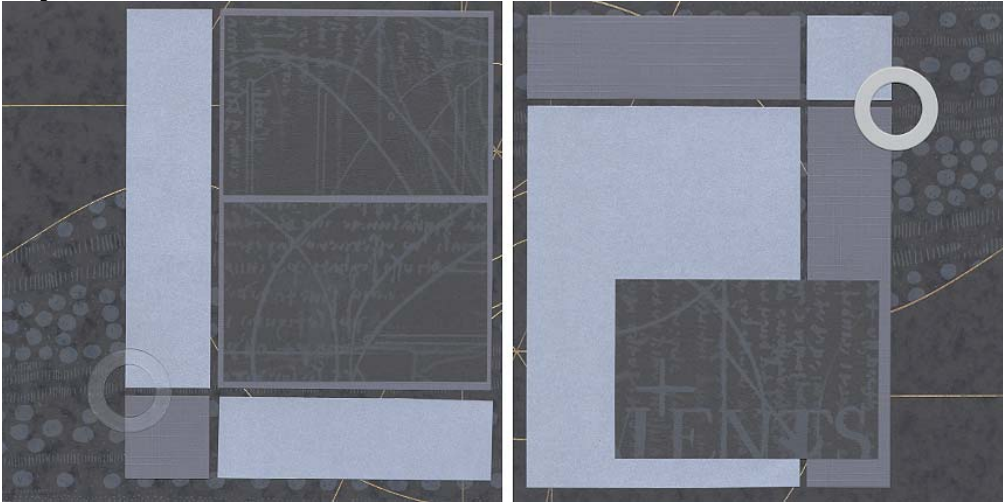

- (2) 12x12 Science Ebony Foil Print
- 8.5x11 Time and Space Silver Plain
- 8.5x11 Workbench Steel Embossed
- 8.5x11 Science Ebony Crepe Print
- Circular Slide Frames

1. Trim the 8.5x11 Silver Plain vertically at 6.5". Stack and rotate; cut at 9".

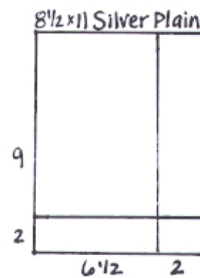

2. Cut the 8.5x11 Ebony Crepe Print horizontally at 10.5 and 6.25". Rotate the 6.25x8.5 horizontally and trim in half at 4.25". Cut the 4.25x8.5 horizontally at 6.25".

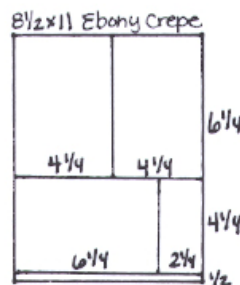

3. Place the 8.5x11 Steel Embossed vertically into the trimmer and cut at 6.5". Stack and rotate; trim at 9".

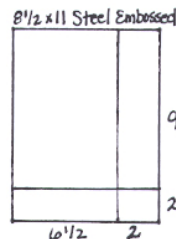

Layout #11 and #12: Nested Mattes

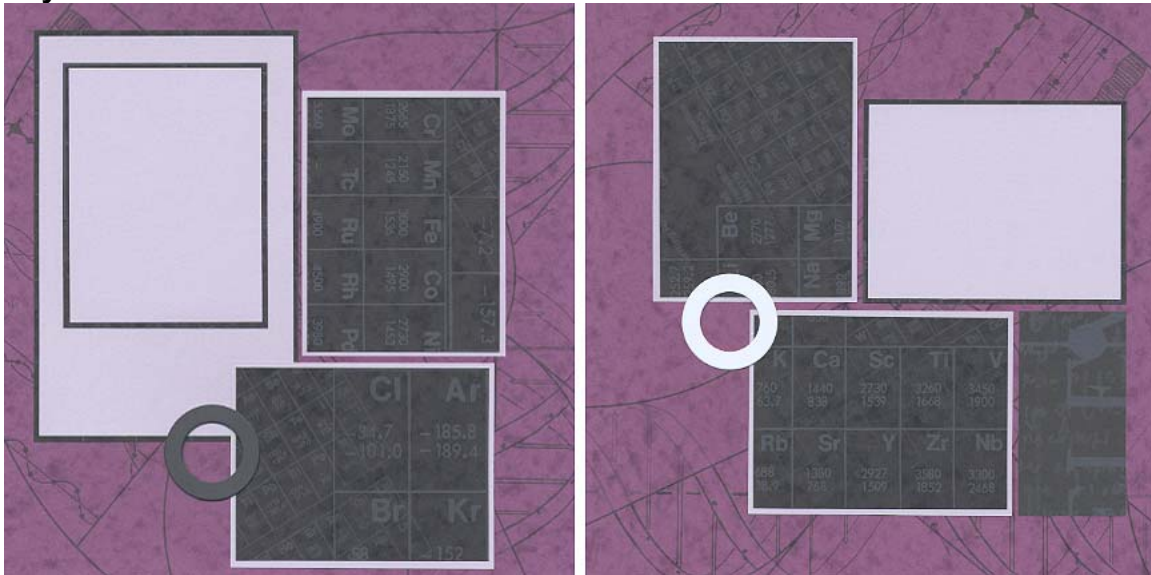

- (2) 12x12 Science Amethyst Print
- (2) 8.5x11 Science Ebony Print
- (2) 8.5x11 Time and Space Mauve Dust Plain
- 2.25x4.25 Science Ebony Crepe Print (From Layout #9 and #10)
- Circular Slide Frames

1. Trim one 8.5x11 Mauve Dust Plain horizontally at 10.75 and 5.5". Rotate the 5.5x8.5 horizontally; cut in half at 4.25". Trim the 5.25x8.5 horizontally at 8.25".

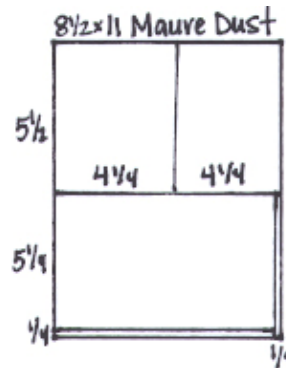

2. Cut one 8.5x11 Ebony Print horizontally at 10.75 and 5.5". Rotate the 5.5x8.5 horizontally; trim in half at 4.25". Cut the 5.25x8.5 horizontally at 8 and 4".

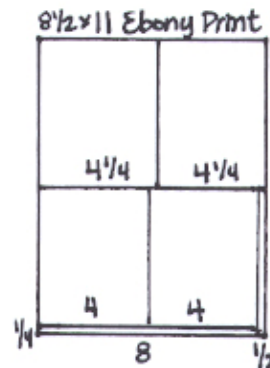

- Trim the 8.5x11 Mauve Dust Plain horizontally at 10.75 and 5.5". Rotate the 5.5x8.5 horizontally; cut in half at 4.25". Trim the 5.25x8.5 horizontally at 8 and 4".

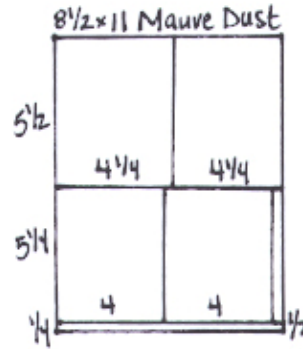

- Trim the 8.5x11 Ebony Crepe Print horizontally at 5.5 and 5.25". Rotate the 5.25x8.5 horizontally; cut at 8 and 4".

