

# Assembly Line Scrapbooking

## February 2008 Club Scrap® Bridges

### Materials:

- Bridges CS® Kit
- Bridges Embellishment Pack
- Bridges Wood Mounted Stamp Set

### Tools:

- 12" Paper Trimmer
- Adhesive/ Glue Lines
- Scotch Tape
- Scissors
- 13" CS® Grid Ruler

### Fraction to Decimal Conversions

$1/8" = .125"$   $1/2" = .5"$   $7/8" = .875"$

$1/4" = .25"$   $5/8" = .625"$

$3/8" = .375"$   $3/4" = .75"$

*Note: We have incorporated items from the Embellishment Pack and Wood Mounted Stamps into many of this month's layouts. If you do not have all of these items, simply make a substitution or eliminate the step.*



The edges of some pages, photo mattes, and die cuts have been defined with brown or black ink. Instructions to ink edges are not included below.

**Layout #1 and #2**

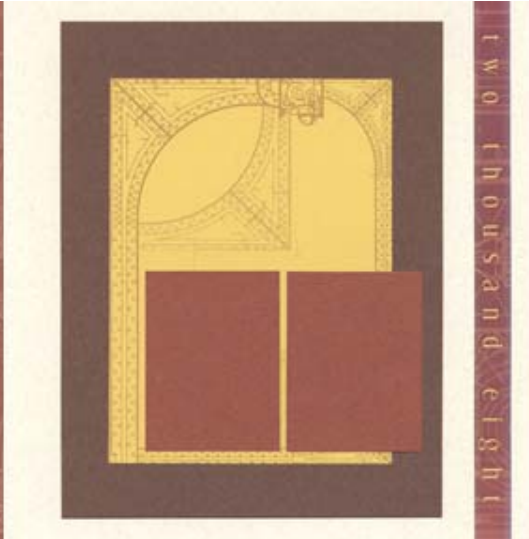

- 12x12 Light Brown Print
- 12x12 Parchment Text Plain
- 8.5x11 Yellow Print
- 8.5x11 Dark Brown Plain
- 8.5x11 Parchment Text Plain
- (2) 4.25x6.25 Dark Brown Plain Photo Mattes
- 4.25x6.25 Light Brown Plain Photo Matte
- 4.25x6.25 Yellow Plain Photo Matte
- Stickers: “Dream & Create” and “Two Thousand Eight”
- Word Poetry Cut Apart

1. Trim the 8.5x11 Yellow Print horizontally along the natural division lines of the print at 6.25”.
2. Cut the 4.25x6.25 Light Brown Plain photo matte vertically at 4”. Rotate horizontally; trim at 6 and 3”.
3. Trim the 4.25x6.25 Yellow Plain photo matte horizontally at 6”. Rotate vertically and cut at 4”.

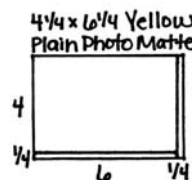
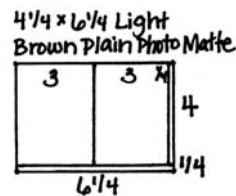
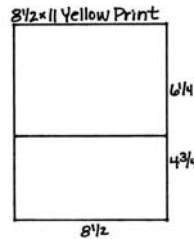

### Layout #3 and #4

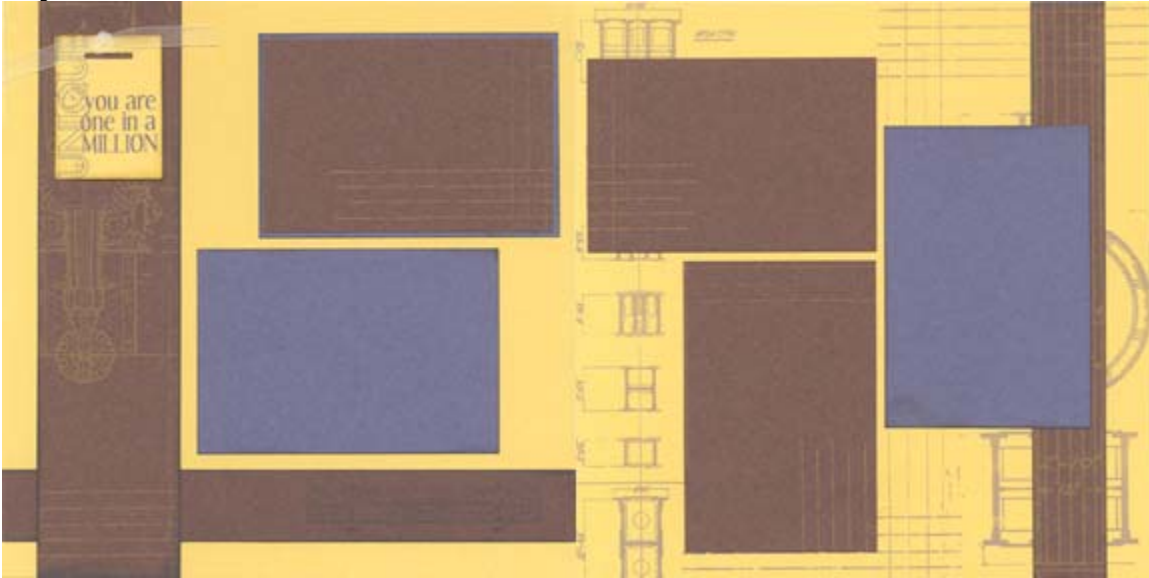

- 12x12 Yellow Plain
- 12x12 Yellow Print
- 12x12 Dark Brown Print
- (3) 4.25x6.25 Stonewash Plain Photo Mattes
- Yellow Perforated Tag: "You are One in a Million"
- Ivory Chiffon Ribbon
- WM Stamp

1. Position the 12x12 Dark Brown Print into the trimmer with the scone image in the top left corner; trim at 10.5, 9, and 3". Rotate the 6x12 horizontally; cut at 8 and 4 to make three 4x6 photo mattes.

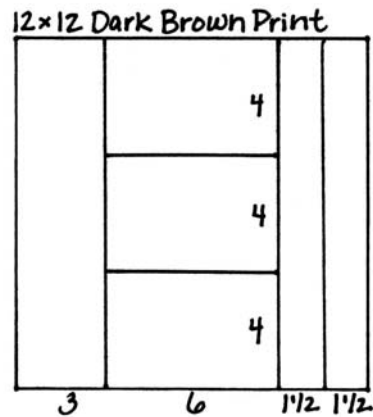

2. Stamp the WM image horizontally onto the plain side of one of the 1.5x12 Dark Brown Print strips.



Layout #5 and #6

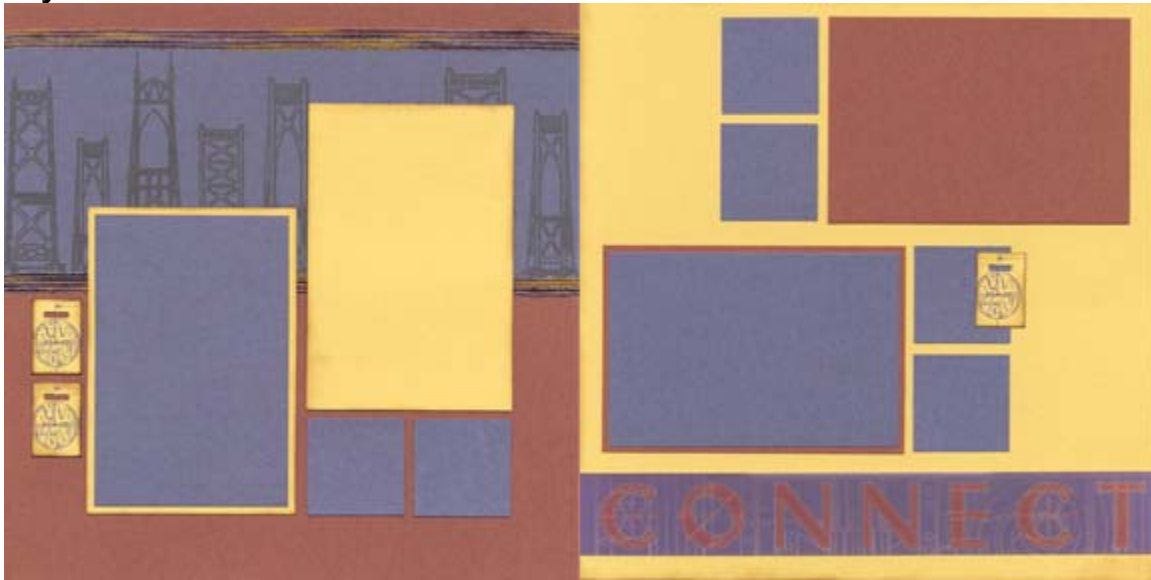

- 12x12 Stonewash Print
- 12x12 Light Brown Plain
- 12x12 Yellow Plain
- (2) 4.25x6.25 Yellow Plain Photo Mattes
- (2) 4.25x6.25 Light Brown Plain Photo Mattes
- (3) Yellow Perforated Tags: Eagle Print
- Stickers: "Connect"
- Multi-Colored Rayon Fiber

1. Place the 12x12 Blue Print into the trimmer with the bridges image on the right side of the page, trim at 7 and 6". Rotate the 6x12 horizontally; cut at 10, 8, and 4". Trim each 2x6 strip horizontally at 4 and 2 to make six 2" squares.

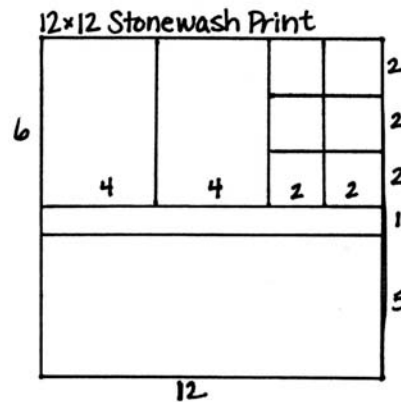

**Layout #7 and #8**

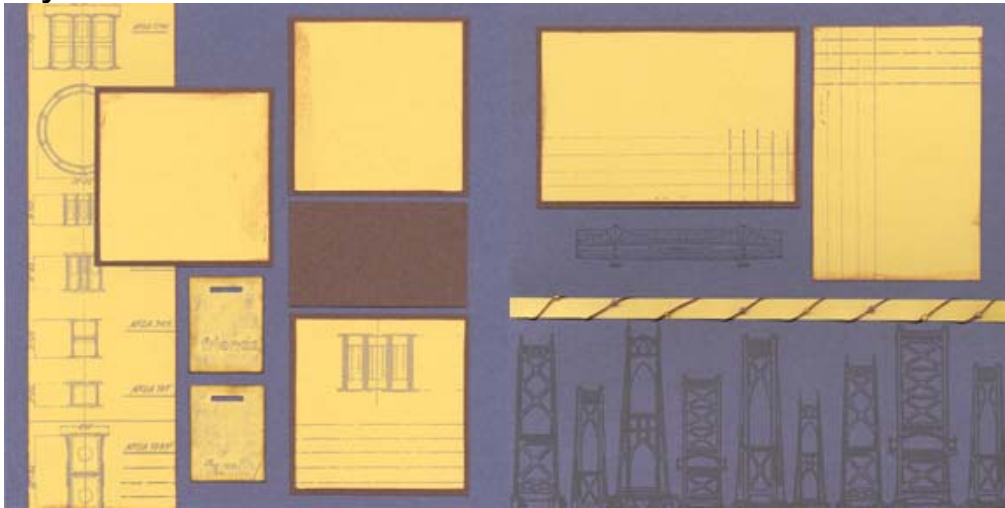

- 12x12 Stonewash Plain
- 12x12 Stonewash Print
- 12x12 Yellow Print
- 8.5x11 Dark Brown Plain
- (2) Yellow Perforated Tags: "Friends" and "Family"
- (8) Beads from the Embellishment Pack
- Rust Waxed Linen Thread
- WM Stamp
- Black Ink

1. Position the 12x12 Yellow Print into the trimmer with the small circle image at the top left corner; trim at 8, 4, and 3.5". Following the sketch, rotate one 4x12 horizontally; cut at 8 and 4" to make three 4" squares. Trim the second 4x12 horizontally at 6".

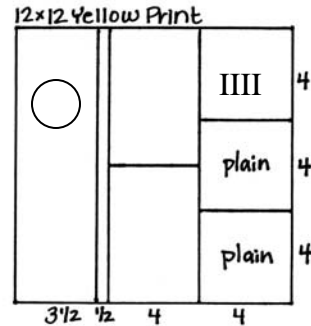

2. Trim the 8.5x11 Dark Brown Plain vertically in half at 4.25". Rotate one 4.25x11 horizontally; cut at 10.5 and 6.25". Trim the other 4.25x11 horizontally at 8.5 and 4.25".

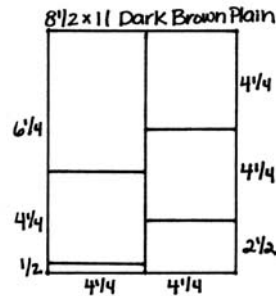

3. Thread the waxed linen thread with 8 beads. Whip stitch around the .5x12 Yellow strip, sliding a bead onto each stitch. Secure the thread ends at the back of the strip with tape and attach to the page.



### Layout #9 and #10

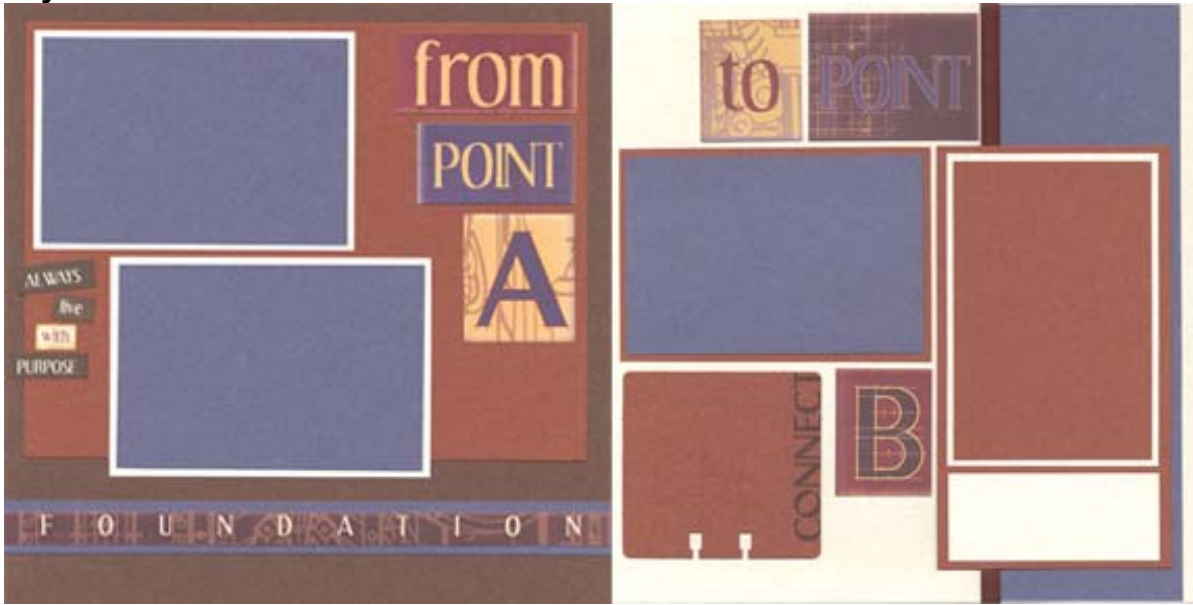

- 12x12 Dark Brown Plain
- 12x12 Parchment Text Plain
- 12x12 Stonewash Plain
- (2) 8.5x11 Light Brown Plain
- 8.5x11 Parchment Text Plain
- 1x12 Stonewash Print (From Layout #5 and #6)
- Stickers: "From," "Point," "A," "to," "Point," "B," and "Foundation"
- Light Brown Die Cut: "Connect"
- Word Poetry Cut Aparts
- Brown Grosgrain Ribbon

1. Trim the 12x12 Stonewash Plain at 10 and 6". Rotate the 6x12 horizontally; cut at 8 and 4 to make three 4x6 photo mattes.

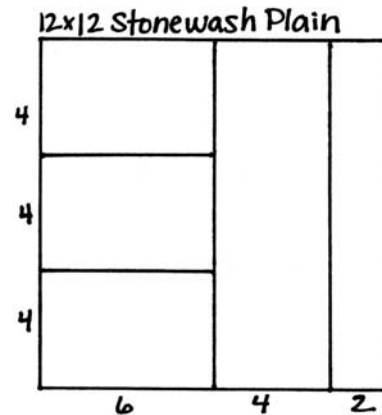

- Cut the 8.5x11 Parchment Text Plain horizontally at 10.5 and 6.25". Rotate the 6.25x8.5 horizontally; trim in half at 4.25". Cut the 4.25x8.5 horizontally at 8 and 6.25".

8 1/2 x 11 Parchment Text Plain

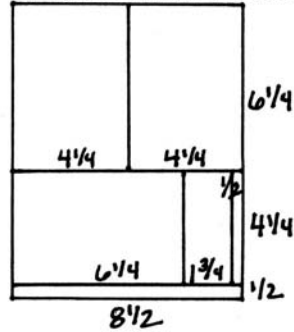

- Trim the 8.5x11 Light Brown Plain horizontally at 6.25". Rotate the 6.25x8.5 horizontally; cut at 8.25 and 4.25". Trim the 4x6.25 horizontally at 6".

8 1/2 x 11 Light Brown Plain

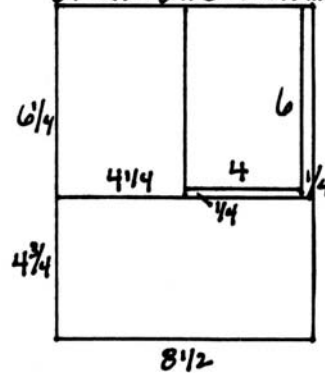

Layout #11 and #12

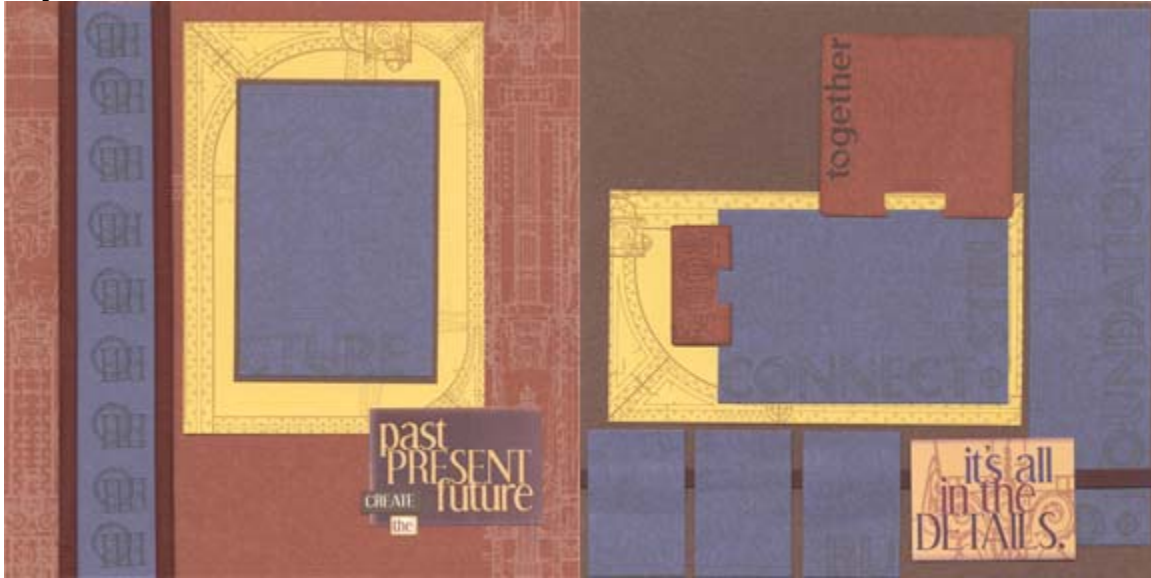

- 12x12 Light Brown Print
- 12x12 Dark Brown Plain
- 8.5x11 Yellow Print
- 8.5x11 Stonewash Print
- 2x12 Stonewash Plain (From Layout #9 and #10)
- 4.25x6.25 Dark Brown Plain Photo Matte
- Stickers: "Past, Present, Future" and "It's all in the Details"
- Word Poetry Cut Aparts
- Cappuccino Grosgrain Ribbon
- WM Stamp
- Black Ink

1. Trim the 8.5x11 Stonewash Print vertically at 6". Rotate the 6x11 horizontally; cut at 8 and 4". Trim the 3x6 horizontally at 4 and 2".

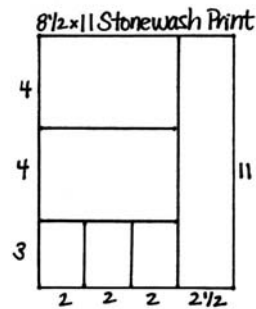

2. Cut the 8.5x11 Yellow Print horizontally along the natural division lines of the print at 6.25".

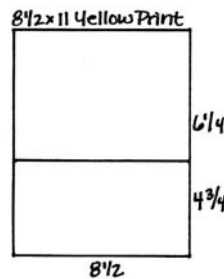

3. Stamp the WM image several times vertically onto the 2x12 Stonewash Plain with black ink.





Layout #13

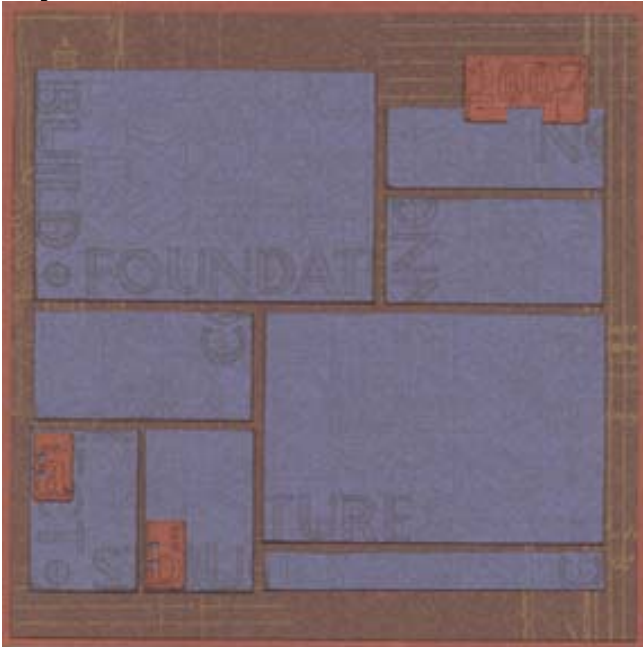

- 12x12 Dark Brown Print
- 12x12 Light Brown Plain
- 8.5x11 Stonewash Print
- Light Brown Die Cuts: "2007," "A," and "B"

1. Trim the 12x12 Dark Brown Print at 11.5; rotate and cut again at 11.5".

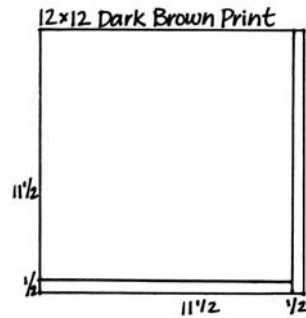

2. Cut the 8.5x11 Stonewash Print horizontally at 7 and 6.25". Rotate the 6.25x8.5 horizontally; trim in half at 4.25". Cut the .75x8.5 horizontally at 6.25". Trim the 4x8.5 horizontally at 7, 5, and 3". Rotate the 3x4 horizontally; cut in half at 2".

